

# 2 WIRE IP SYSTEM 4 inch Guard Station

# CCIP

COLOR TFT TOUCH SCREEN WITH HANDSET

## Operation Manual

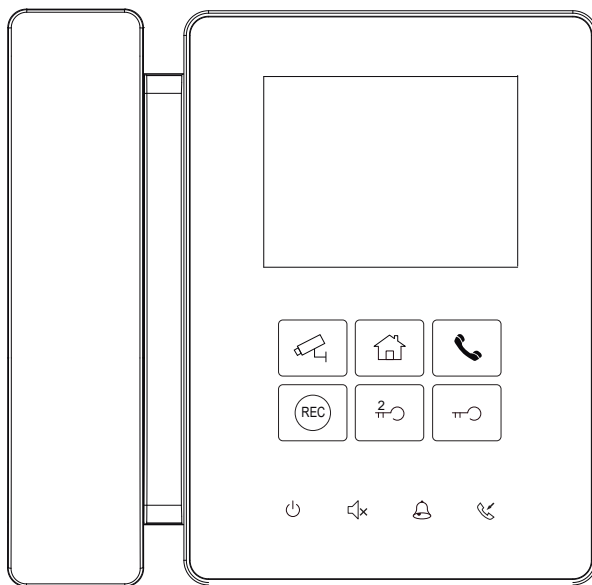

- Please read this manual carefully before using the product you purchase, and keep it well for future use.
- Please note that images and sketch maps in this manual may be different from the actual product.

## PRECAUTIONS

- Slots or openings in the back of the monitor, are provided for ventilation and to ensure reliable operation of the video monitor or equipment and to protect it from overheating. These openings must not be blocked or covered. The monitor should never be placed near or over a radiator or heat register and should not be placed in a built-in installation such as a bookcase unless proper ventilation is provided.
- All parts should be protected from violence vibration. And not allow be impacting, knocking and dropping.
- For clean the LCD screen, using hands or wet cloth is forbidden.
- Please do the cleanness with soft cotton cloth, please do not use the organic or chemical clean impregnate. If necessary, please use pure water or dilute soap water to clean the dust.
- Image distortion may occur if the video door phone is mounted too close to magnetic field e. g. Microwaves, TV, computer etc.
- Please keep away the video door monitor from wet, high temperature, dust, and caustic and oxidation gas in order to avoid any unpredictable damage.
- Do NOT open the device in any condition, call the administrator for help if there is any problem or malfunction happens.

## CONTENTS

PARTS AND FUNCTIONS .....	4
Part Names.....	4
Mounting.....	5
Screen .....	6
BASIC OPERATIONS .....	7
Answering a call .....	7
Basic operation based on Namelist.....	8
Select a user or a Guard Station to be called.....	8
Select a video door station to be monitored .....	9
Select a door station to be released the lock.....	9
Basic operation by Input code .....	10
Call a user or a Guard Station.....	10
Monitor a video door station .....	10
Release a door lock.....	11
Recording .....	11
Viewing videos.....	12
Viewing calling records.....	13
SETUP INSTRUCTIONS.....	14
Setting date and time.....	14
Setting monitor time.....	14
Setting ring tone & ring volume .....	15
Setting IP address .....	15
Specification .....	16

## Part Names

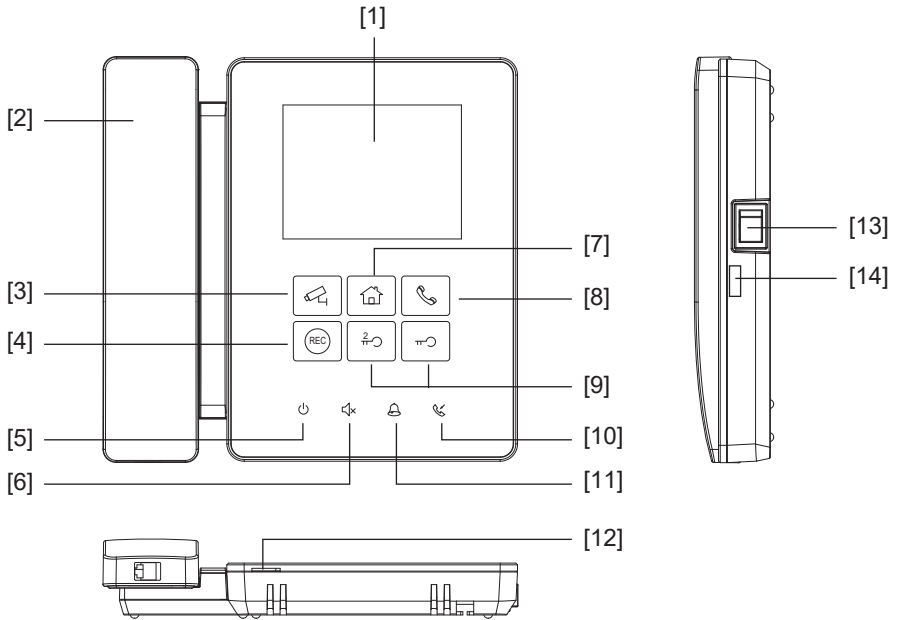

## Key functions

NO.	Item	Description
[1]	Color LCD touch screen	<ul style="list-style-type: none"> <li>• See the menu details</li> <li>• Display videos and images</li> </ul>
[2]	Handset	Pick up to answer the call
[3]	Monitor button	Monitor the video from the selected Door Station
[4]	Manual record button	Press to capture videos
[5]	Close button	<ul style="list-style-type: none"> <li>• Press to open/close the main menu page.</li> <li>• End the communication, monitoring, or call.</li> </ul>
[6]	Mute button	Reserve
[7]	Home button	Press to return to main menu page
[8]	Call button	Press to call the users or other Guard Stations
[9]	Unlock button	Press to release the door lock
[10]	Transfer button	Reserve
[11]	Missed call button	<ul style="list-style-type: none"> <li>• Light up when having missed call</li> <li>• Press to open the missed call records in shortcut</li> </ul>
[12]	Speaker	Send out sounds of ring tones, audio and alarms
[13]	Power switch	Press to power off/on for the unit
[14]	SD card slot	Use to insert micro-SD card (SD card not included)

\* Monitor/Home/Call/Manual record/Unlock button will be light up when power on for the unit.

## Mounting

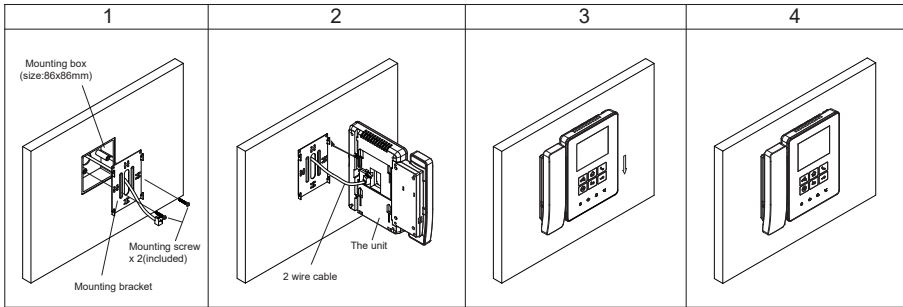

The installation height is suggested to 145~160cm.

1. Use screws to fasten the mounting bracket to the wall with mounting box.
2. Connect the power to the unit.
3. Mount the unit to the mounting bracket, make sure the magnet on the unit is absolutely attached to the mounting bracket.
4. Final view.

## Terminal description

L1,L2: Power input,no polarity.

RS485: Reserve.

RELAY: Reserve.

CRJ45: RJ45 converter terminal,  
connect to Ethernet.

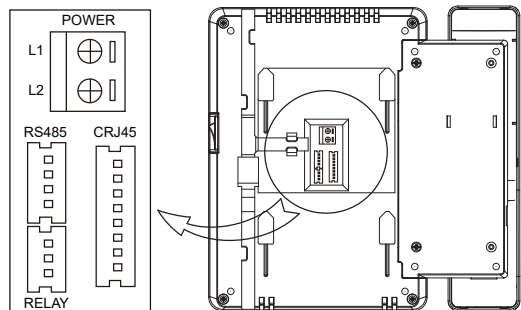

## Screen

### Main screen

The Main menu is your starting point for using all the applications on your monitor.

Press  [Home] button or touch anywhere of the screen on monitor in standby mode, the Main menu will appear as follow:

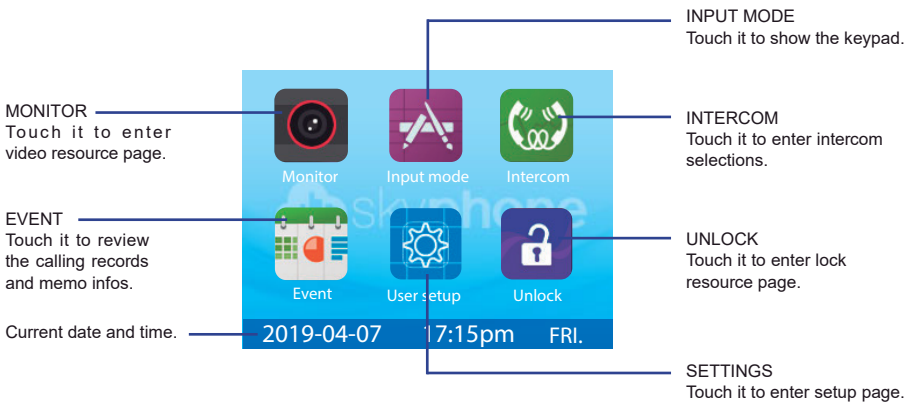

### Serach screen

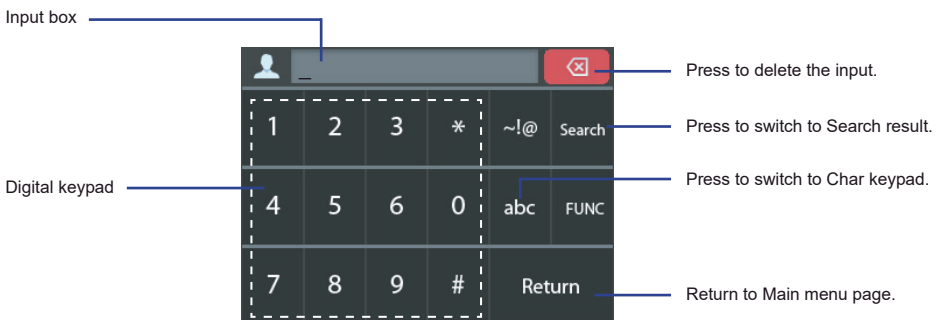

On Main menu page,touch  [Input Mode] icon to display the Search screen.

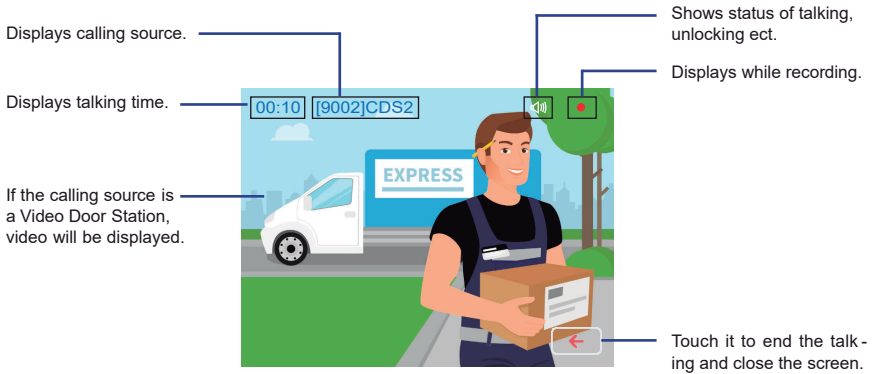

## Communication screen



## Answering a call

- When receiving a call, the call tone sounds, video will be displayed on the screen if the source is a Video Door Station, and one video will be recorded for 10 seconds automatically if there is video.
- Pick up handset to communicate with the caller for 90 seconds.
- While communication, press  /  [Unlock] button to release the corresponding door lock.
- When the communication ends, hang up handset or press  [Close] button.

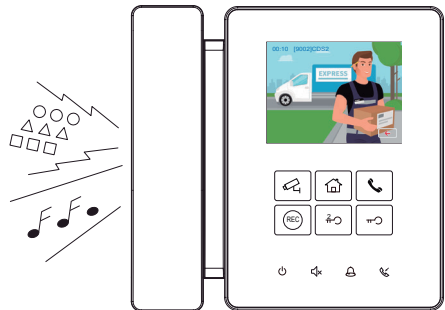



- If nobody answers the call, the screen will be turned off automatically after 30 seconds.
- The image will not be displayed when receiving a call from User or Other Guard Station.
- Manual recording is forbidden during auto recording.
- While receiving a call, other calling is forbidden.
- Communication also ends automatically after 90 seconds.

## Basic operation based on Namelist

In default, the Namelist is not included. It should be configured by specific software. The following instructions are in the condition of the namelist is created.

1. Select a User or a Guard Station to be called

1. On Main menu, touch  [Intercom] icon to display Namelist. Touch  icon to switch between User List and Guard Station List.

2. Select a Name by touching it, calling is activated immediately. No image will be displayed on screen.

### User List





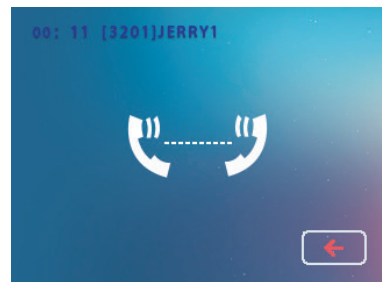

### Guard Station List



3. If nobody answers the call within 30 seconds, it will stop calling automatically and shut off the screen. Or touch  icon to stop calling directly.

4. If the call is answered, communication is starting.

5. When the communication ends, hang up handset or press  [Close] button.

-  Scroll to next page.
-  Scroll to last pages.
-  Switch between User and Guard Station List.
-  Return to Main menu page.



## 2. Select a Video Door Station to be monitored

1. On Main menu, touch  [Monitor] icon to display Video resource list.







2. Select a Video Door Station by touching it, monitoring is activated immediately. The monitor time is 30 seconds.

3. The image of outdoor condition will be displayed on screen, see as follow:





4. During monitoring, these operations are available:

- Pick up handset to talk with visitor;
- Press  /  [Unlock] button to release the door lock;
- Press  [Manual record] button to record videos.
- Press  [Close] button to end monitoring.

## Select a door station to be released the lock

1. On Main menu, touch  [Unlock] icon to display Door Station list.



2. Select a Door Station by touching it, then press  /  [Unlock] button to release the corresponding lock.

3. If the door is open, the screen will pop-up a box of unlocking. If unlocking is failed, the screen will pop-up a box of device connection error, see as follows:

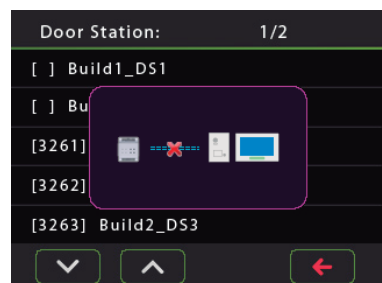
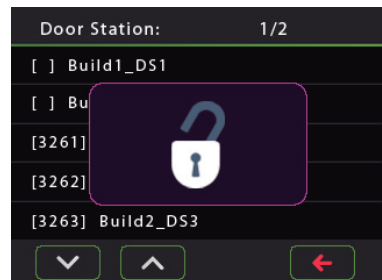

## Basic operation by Input

The another way to activate the functions of calling, monitoring, unlocking is by inputting code via the keypad on screen. There are two different types of code: Default code and Room code.

Default code: logical device address, set by DIP switch.

Room code: configured by software. In default, the room code will not listed on Guard Station.

### 1. Call a User or a Guard Station

On Main menu, touch  [Input Mode] icon to display Search screen, or press

 [Call] button in shortcut.

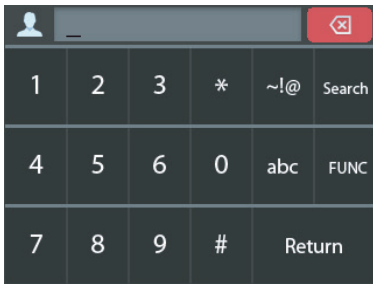

#### 1) Call by Default code:

Input the Default code on input box, then press  [Call] button, calling is activated immediately.

The Default code is composed of 3-digits DT-IPG IP\_NODE\_ID address and 3-digits Monitor or Door Station address.

For example:

To call the 02 address Monitor inside IP gateway address IP\_NODE\_ID=12, input 012002

Please note the above numbers are logical device address, not input numbers or call address.

#### 2) Call by Room code:

(a) Input the Room code on input box if you remember the room code clearly, then press  [Call] button, calling is activated immediately.

(b) If you don't remember the room code clearly, you can use the function of fuzzy search. Searching by digital numbers or by name is available.

#### Search by digital numbers:

For example, maybe you just remember the room code including the numbers of 32, input the code 32 on input box, then touch the key "Search", all Namelist including the code of 32 will be displayed.



Select the target you want, then press  [Call] button to activate calling.



Search by name:

Maybe you just know the name of User or Guard Station. For example, input the name "jim" on input box, then touch the key "Search", all Users or Guard Stations called "jim" will be displayed.



Select the target you want, then press  [Call] button to activate calling.



## 2. Monitor a Video Door Station

1. On Main menu, touch  [Input Mode] icon to display Search screen, or press  [Monitor] button in shortcut.



2. The inputting method is the same as the section of Calling User or Guard Station.

3. Select the Video Door Station you want, then press  [Monitor] button to activate monitoring.

## 3. Release a door lock

1. On Main menu, touch  [Input Mode] icon to display Search screen, or press  /  [Unlock] button in shortcut.

2. The inputting method is the same as the section of Calling User or Guard Station.

3. Select the Door Station you want, then press  /  [Unlock] button to open the corresponding door.

## Recording

Videos are possible to be recorded, and both automatic recording and manual recording are available. To record videos, SD card is needed.

### Automatic recording

Recording starts immediately when receiving a call.

- While recording, "●" displays on the screen.
- Capture one video automatically for each calling.



The recorded videos are stored in SD card directly.

\* Max. 32G Micro SD card is supported.

Note:

\* Automatic recording function cannot be cancelled.

\* Automatic recording does not available while monitoring a door station. To save videos while monitoring, see manual recording below.

## Manual recording

While be called,talking or monitoring,Touch  button when an image is displayed.

Note:

\* Manual recording is available at any time.

\* Manual recording cannot be performed during automatic recording.

- 1.The auto recording time limited is 10s. The videos will be saved on micro SD card directly.
- 2.The manual recording time is the time for ending manual recording,max.10s for each manual recording.
3. A brand new SD card needs to be formatted by the monitor, then it can be used for video recording.

## Viewing videos

The recorded videos can be playback on Guard Station. Follow the steps:

- On main menu page, touch [Events] ->[Memo] icon, most recent recordings are displayed.
- Touch " < " or " > " to scroll through recordings,touch "  " to delete current video.

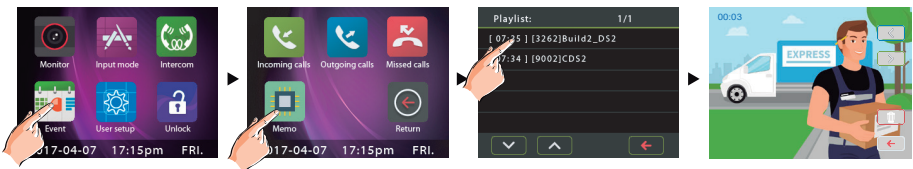

To stop

Touch  icon on the screen during play to return to last page.

Press  [Home] button to return to main menu page.



## Viewing calling records

All calls of incoming, outgoing, missed will be recorded and can be reviewed afterwards.

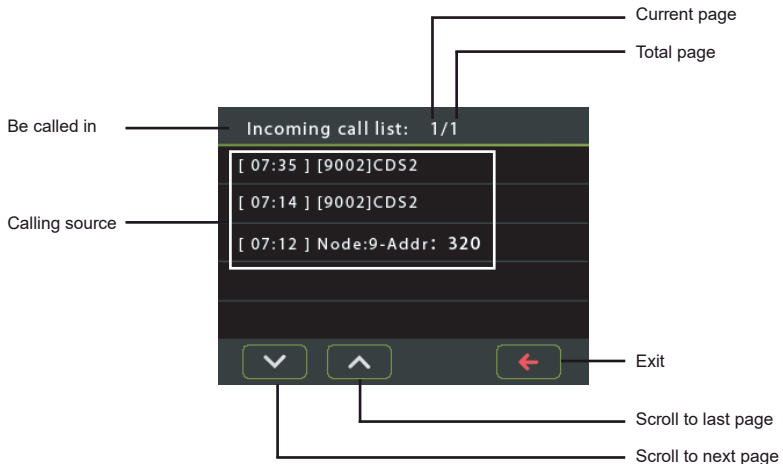
On main menu page, touch [Event] -> [Incoming call] icon, the most recent incoming call records are displayed.



You can review the calling details.

1. Touch one of the calling list.
2. Touch  icon to show the caller's image if there is a video, or touch  icon to recall the station.

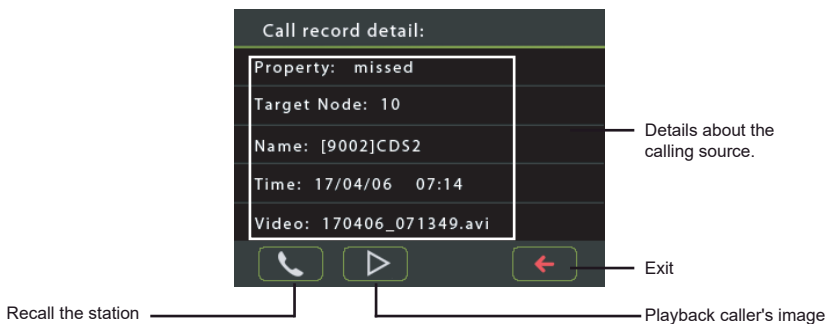

Note:

\* The operation of viewing outgoing call and missed call are the same as incoming call.

\* Max. 100 calling records can be displayed

\* When the capacity is full, the oldest calling recordings will be deleted automatically to make room for new records.

## Setting date and time

You can correct the current date and time any time by following the procedure below.

1. On main menu page, touch icons [User Setup] -> [Date&Time] to enter Date&Time setting page.
2. Touch the setting target of year, month, date, hour, minute and second individually, then input the value by touching the digital keypad.
3. When the setting has finished, touch ✓ to save the settings.



- Note:
1. Touch **12h** [12h/24h] icon to set the time standard.
  2. Touch **m-d-y** [m-d-y/d-m-y] icon to set the date format.
  3. Press  [Home] button to return to main menu page or touch "Return" key to return to last page.

## Setting monitor time

The monitor time can be changed at any time. The setting range is 1s~999s.

\* 30s is the default monitor time.

1. On main menu page, touch icons [User Setup] -> [Monitor Time] .
2. Input the value by touching the digital keypad.
3. When the setting has finished, touch ✓ to save the settings.

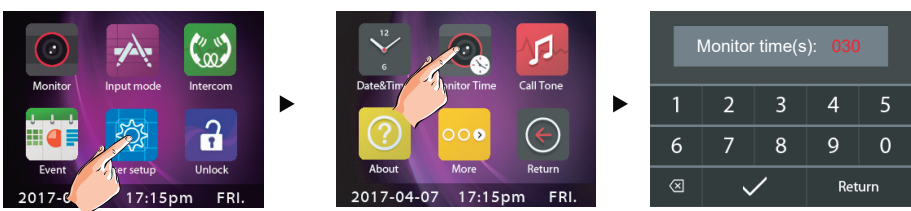

- \* Press  [Home] button to return to main menu page or touch "Return" key to return to last page.

## Setting ring tone&ring volume

The ring call tone can be set individually to distinguish different calling source. Total 20 tones can be selected.

1. On main menu page, touch icons [User Setup] -> [Call Tone] to enter Call Tone Select page.



Ring Volume: setting the ring volume when receiving calls, the setting range is 1~9.

DS Call Tone: setting the ring tone when receiving calls from door stations.

GS Call Tone: setting the ring tone when receiving calls from other Guard Stations.

IM Call Tone: setting the ring tone when receiving calls from users.

- \* Touch the box to change the value, touch one time to set one value.
- \* After selected the value, touch ✓ to save and perform the settings.
- \* Touch **Default** icon to restore the 4 settings to default value.

## Setting IP address

IP\_NODE\_ID is the critical address in 2-wire IP system, instead of traditional IP address configurations. All IP devices in a network system must be set differently.

For Guard station, set the IP\_NODE\_ID address(NODE in setting menu) by manual, range from 201 to 232.

Unless modified by means of configuration software, DT-IPG use default IP address as:

IP segment: 192.168.243

IP subnet mask: 255.255.255.0

Gateway: 192.168.243.200

IP\_NODE\_ID will be the IP address last segment number, for example:

If a DT-IPG DIP switches are set to IP\_NODE\_ID=201, this DT-IPG IP address will be 192.168.243.201

On main menu page,touch icons [User Setup] ->[More] ->[System Settings] , a password will be asked.

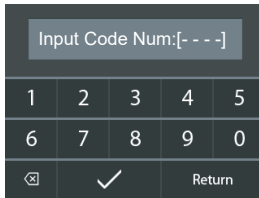

Input the Code Num 8001,press “✓” to save the setting and enter IP Address page.

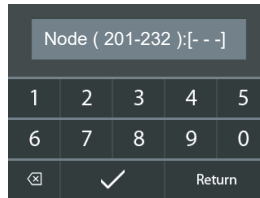
Input the IP Address by touching the digital keypad on input box, press “✓”to save the setting.

## Specification

Power supply:	DC 24V, no-polarity
Consumption current:	Standby 50mA, maximum 150mA
Communication:	Handset
Screen:	4 Inch digital color TFT
Display Resolutions:	320(R, G, B) x 240 pixels
LAN Ethernet:	10BASE-T, 100BASE-TX
Network Protocol:	IPv4, TCP, UDP, RTSP, RTP, RTCP, IGMP, DHCP, NTP
Audio codec:	G.711(64Kbps)
Video codec :	H.264/AVC (VGA, QVGA)
Mounting:	Surface wall-mount, on desktop
Material:	Plexiglass panel
Color:	White
Operating temperature:	0 °C ~ +40 °C
Dimension:	187(H)×191(W)×36(D)mm